

I/O Models

Kartik Gopalan

Types of Concurrency

- True Concurrency (multiple processes or threads)
 - Multi-processor machines
 - Child processes/threads execute in parallel.
 - Multi-process (forking) servers
 - If one child server blocks, another executes
 - Multi-threaded servers
 - If one thread blocks, another executes.
 - Only if threads supported by kernel
- Apparent Concurrency
 - Single process does multiplexing among multiple clients.
 - E.g. I/O multiplexing with `select()`.
 - Multi-threaded Server (again!)
 - If threads implemented at user level.

True Concurrency: Forking Concurrent Servers

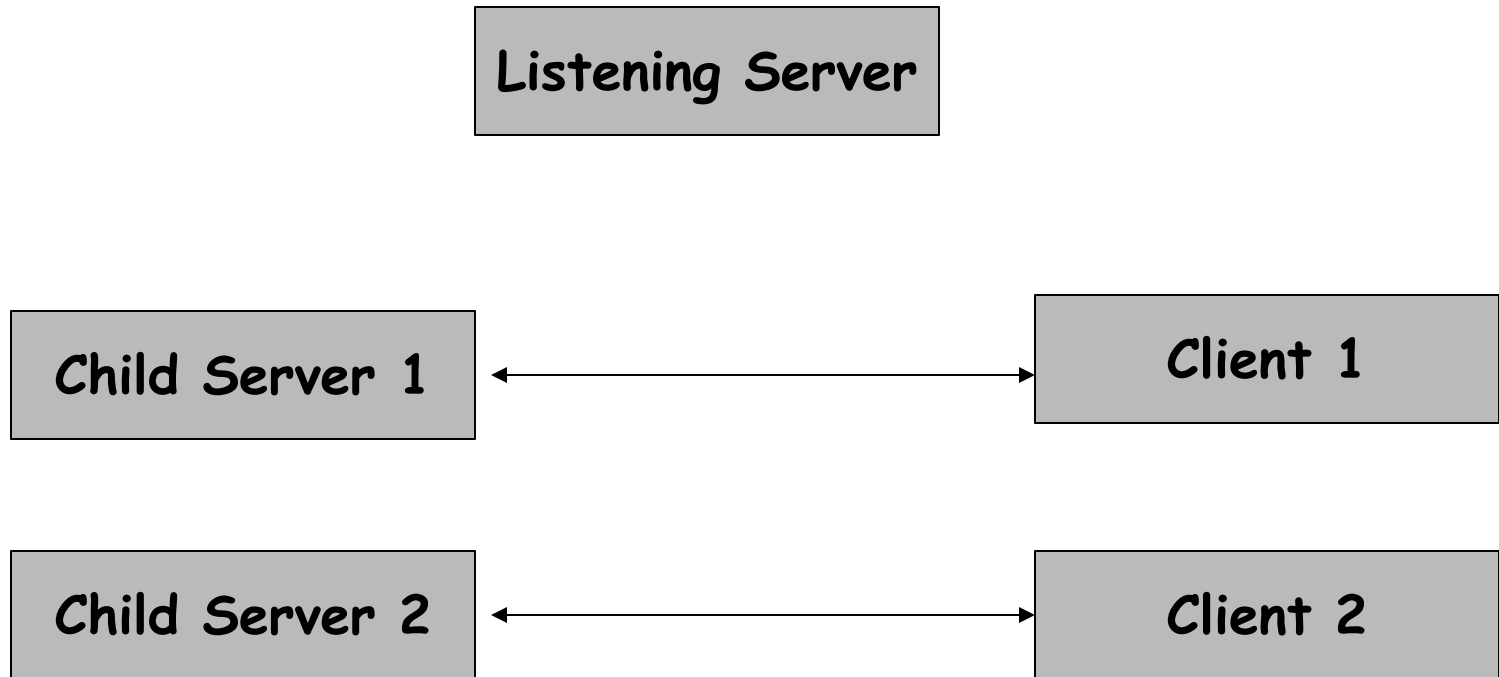

Apparent Concurrency

Non-Forking Concurrent Server

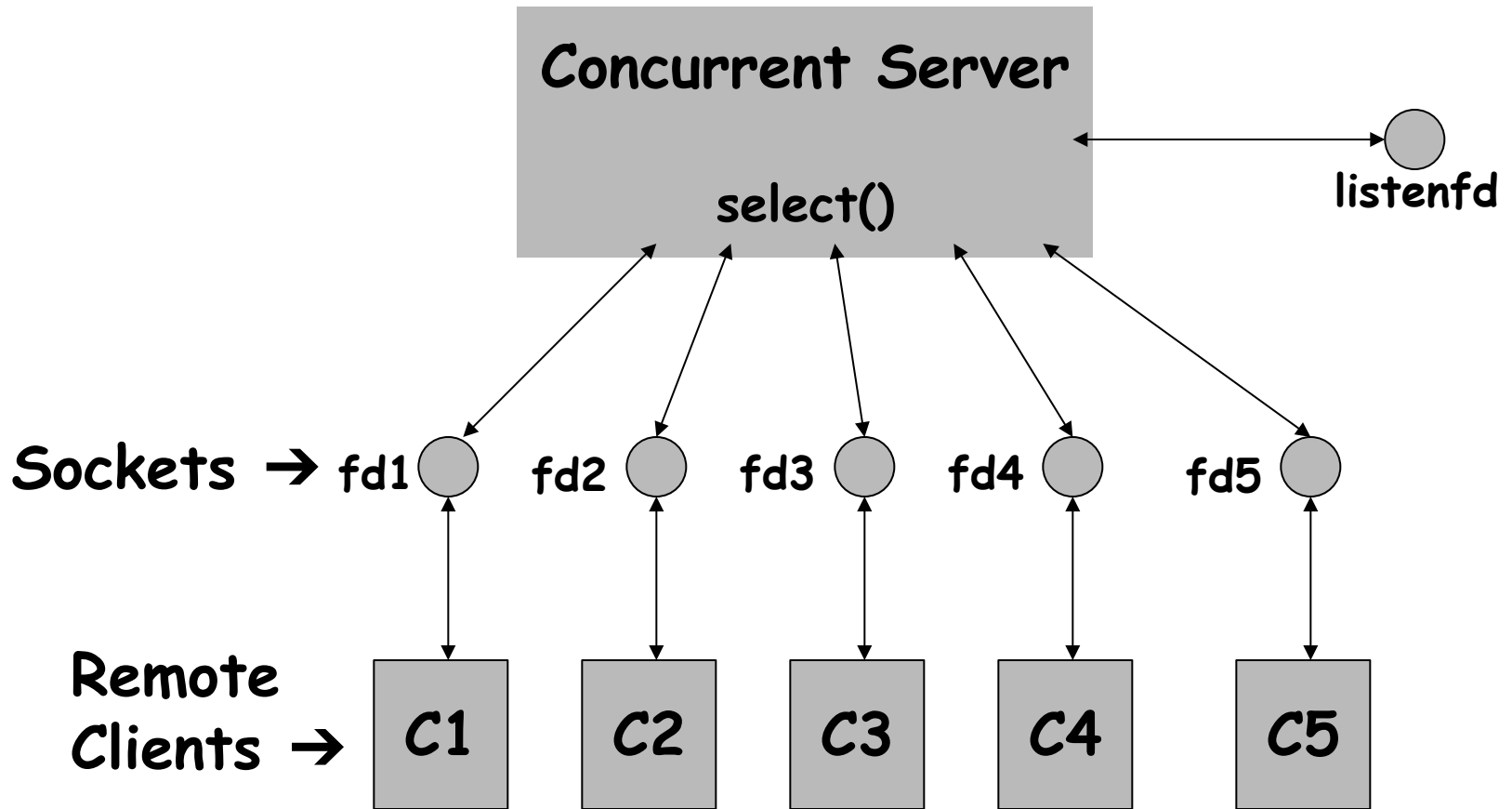

I/O Models

- Blocking I/O
- Non-blocking I/O
- I/O multiplexing – `select()`
- Signal driven I/O
- Asynchronous I/O

Two steps in data reception

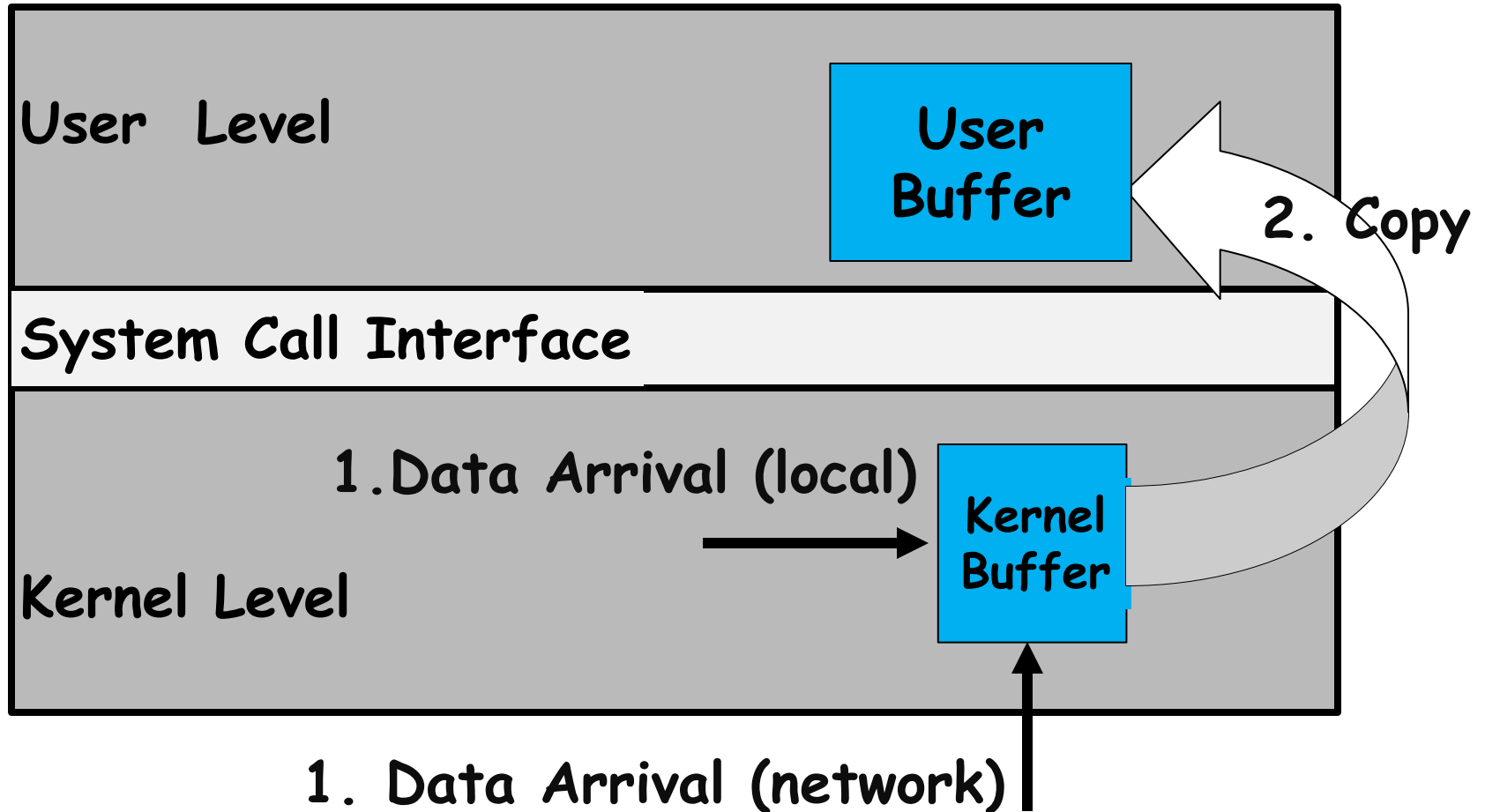

Overheads: Context switching, Data copying

Blocking I/O

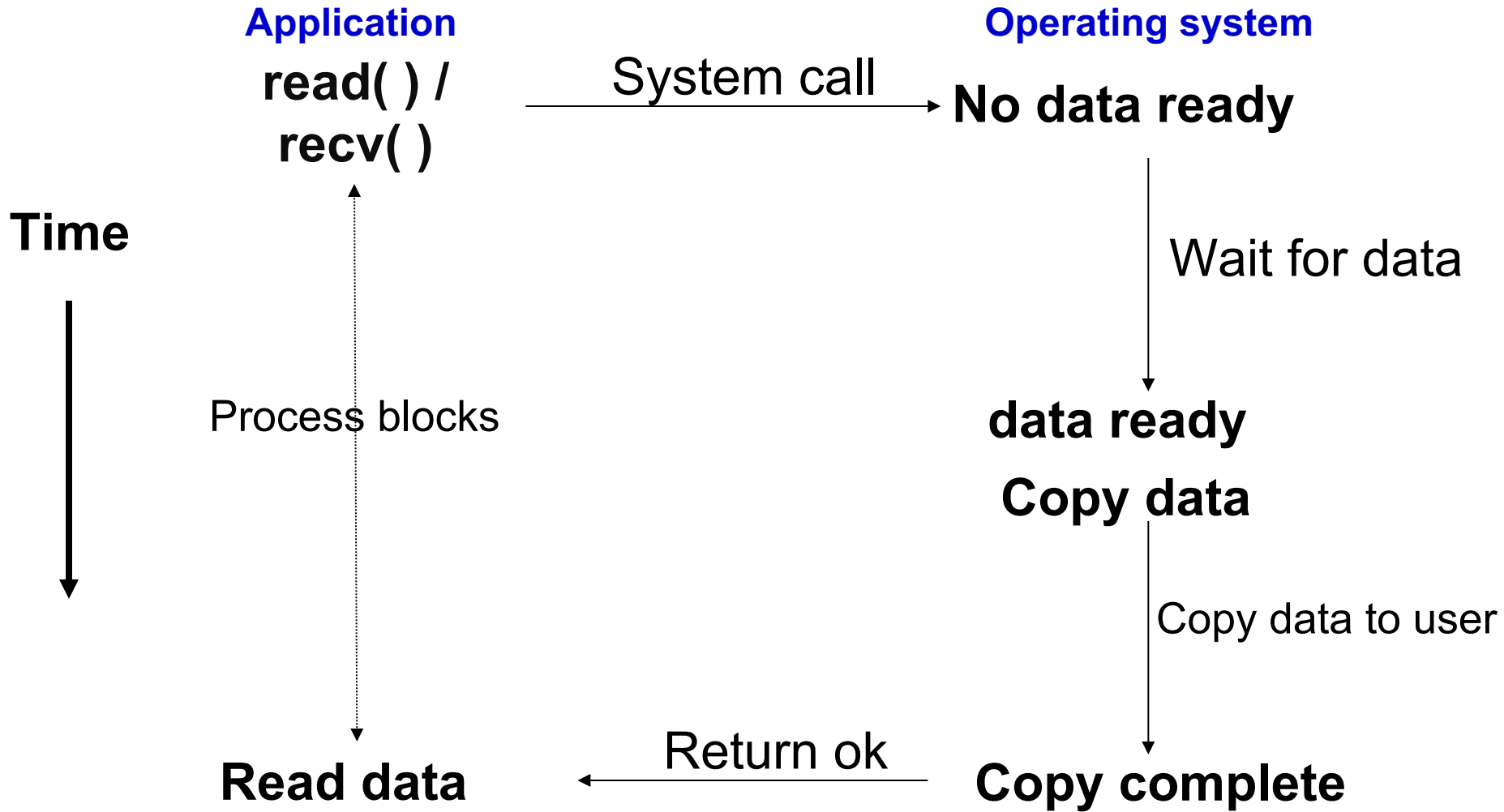

Non-Blocking I/O (polling)

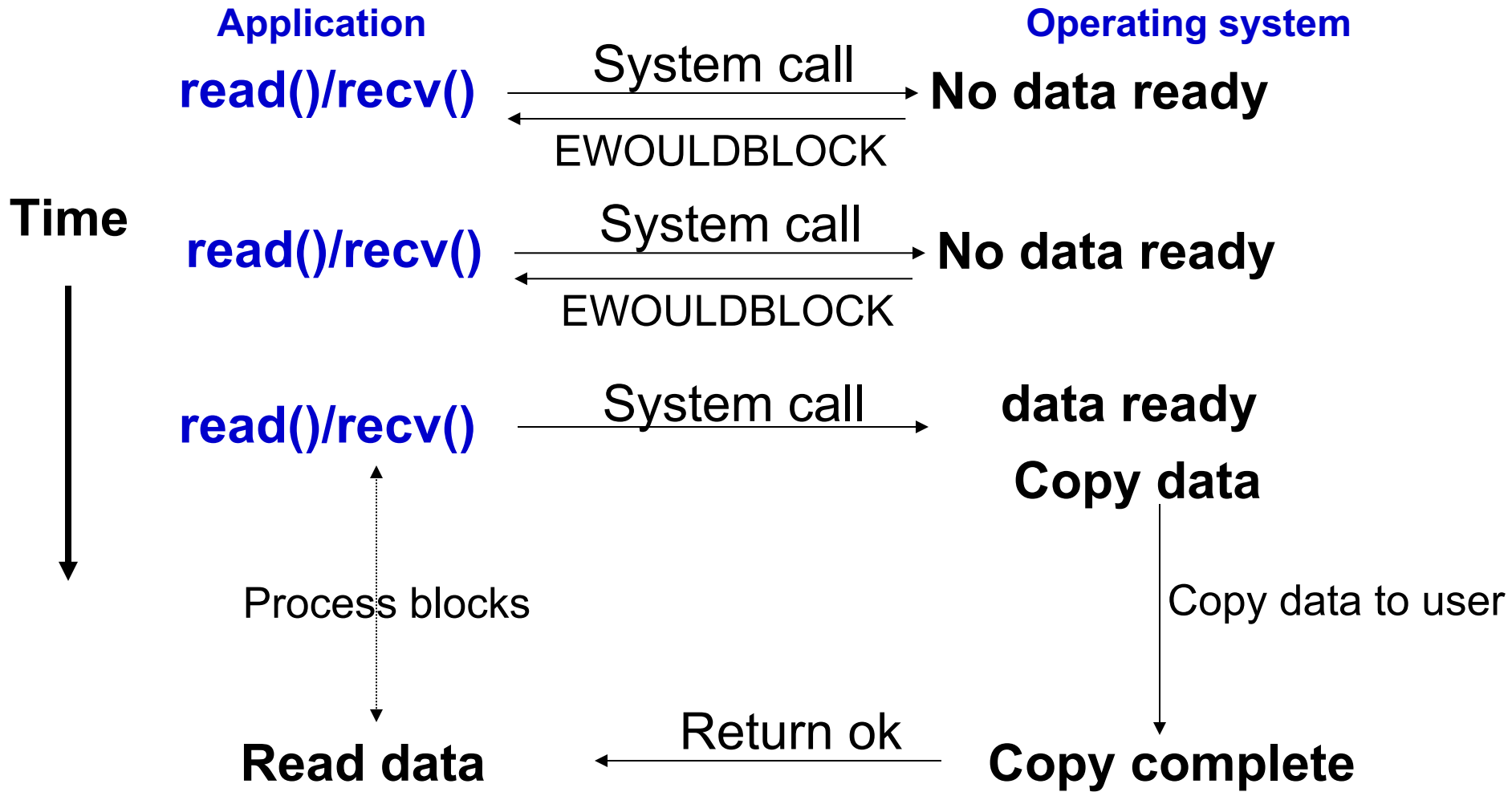

I/O Multiplexing

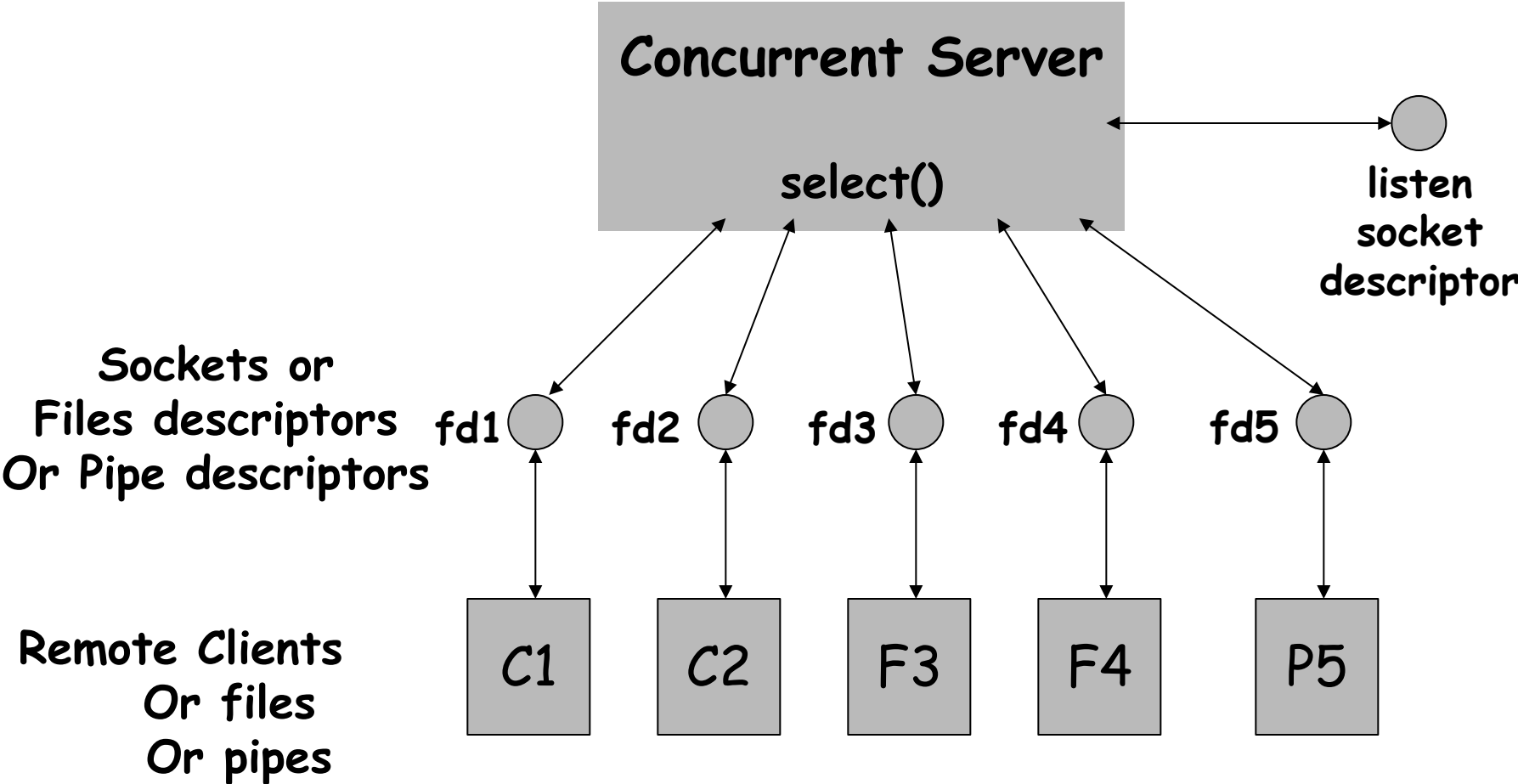

I/O Multiplexing

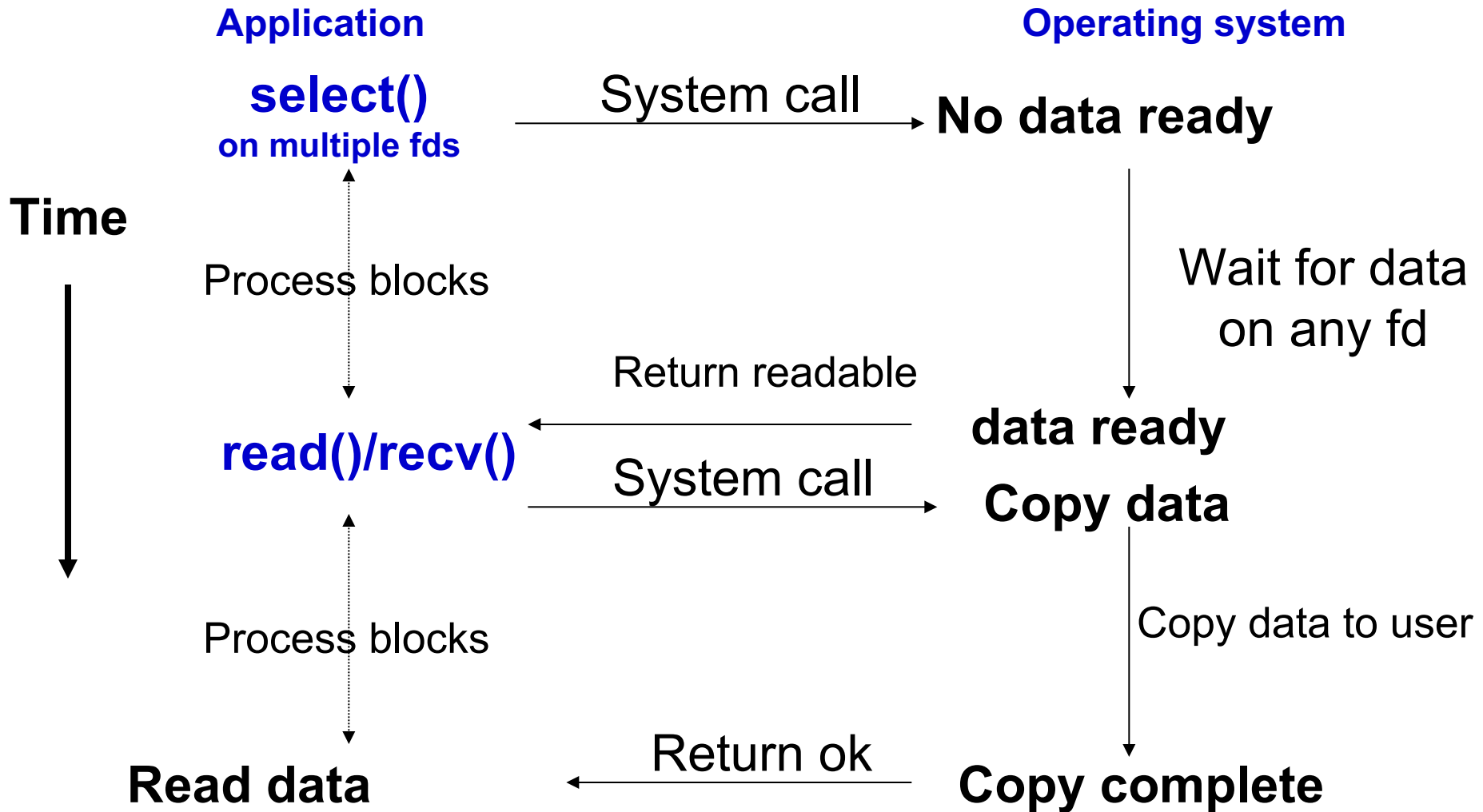

Signal driven I/O

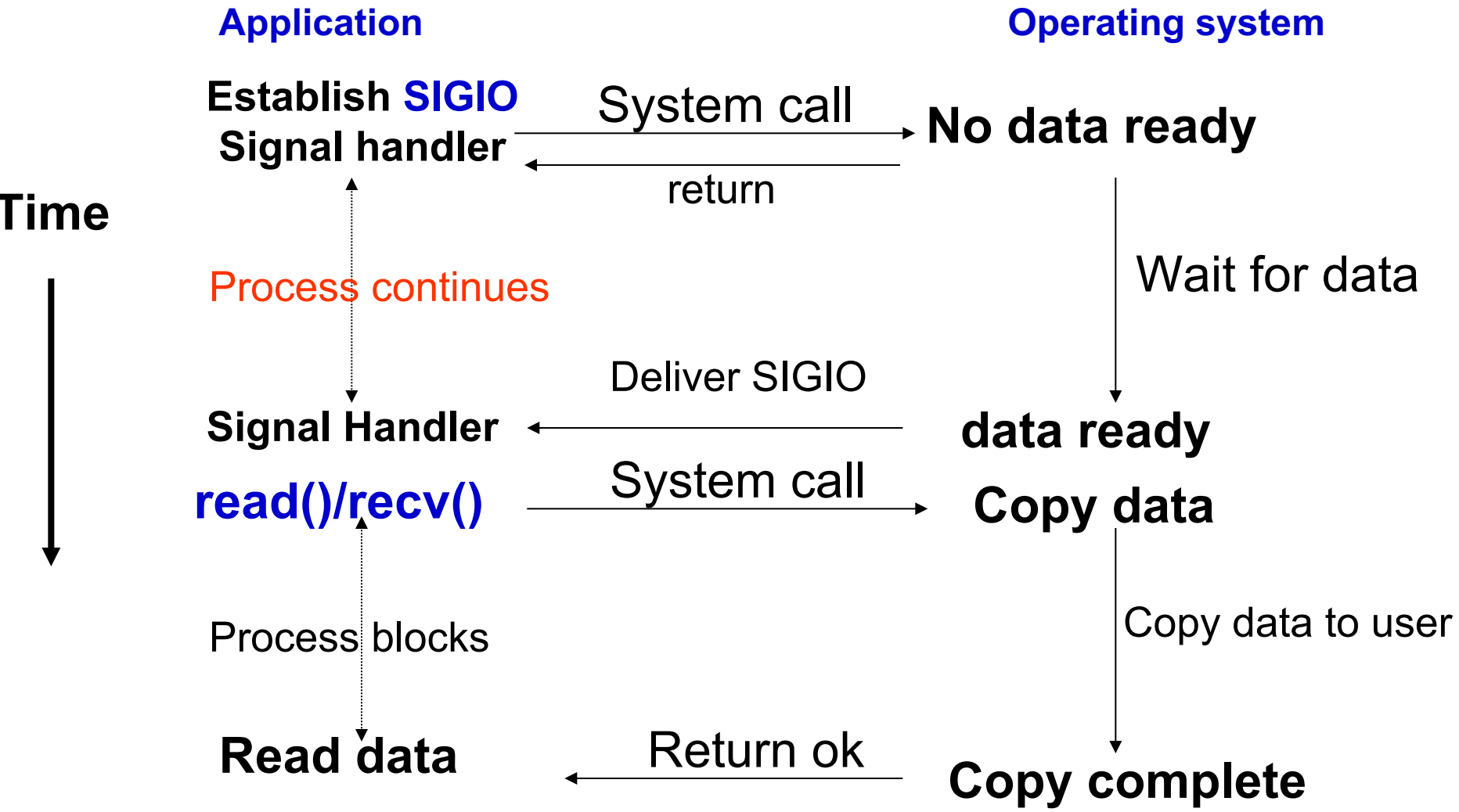

Asynchronous I/O

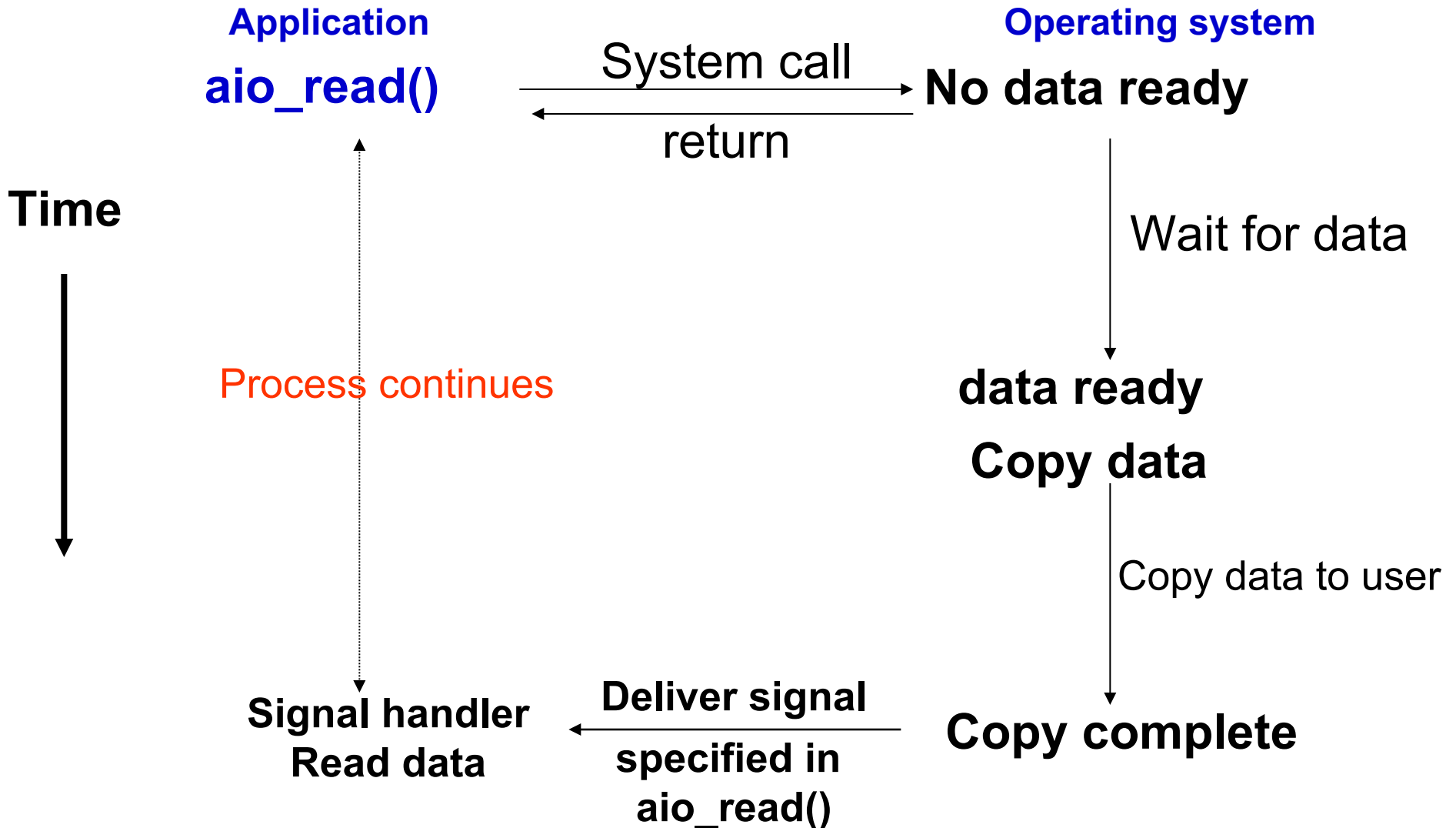

I/O Multiplexing

Example of Event-oriented programming

What is I/O multiplexing?

- When an application needs to handle multiple I/O descriptors at the same time
 - E.g. file and socket descriptors, multiple socket descriptors
- When I/O on any one descriptor can result in blocking

Non-forking concurrent server

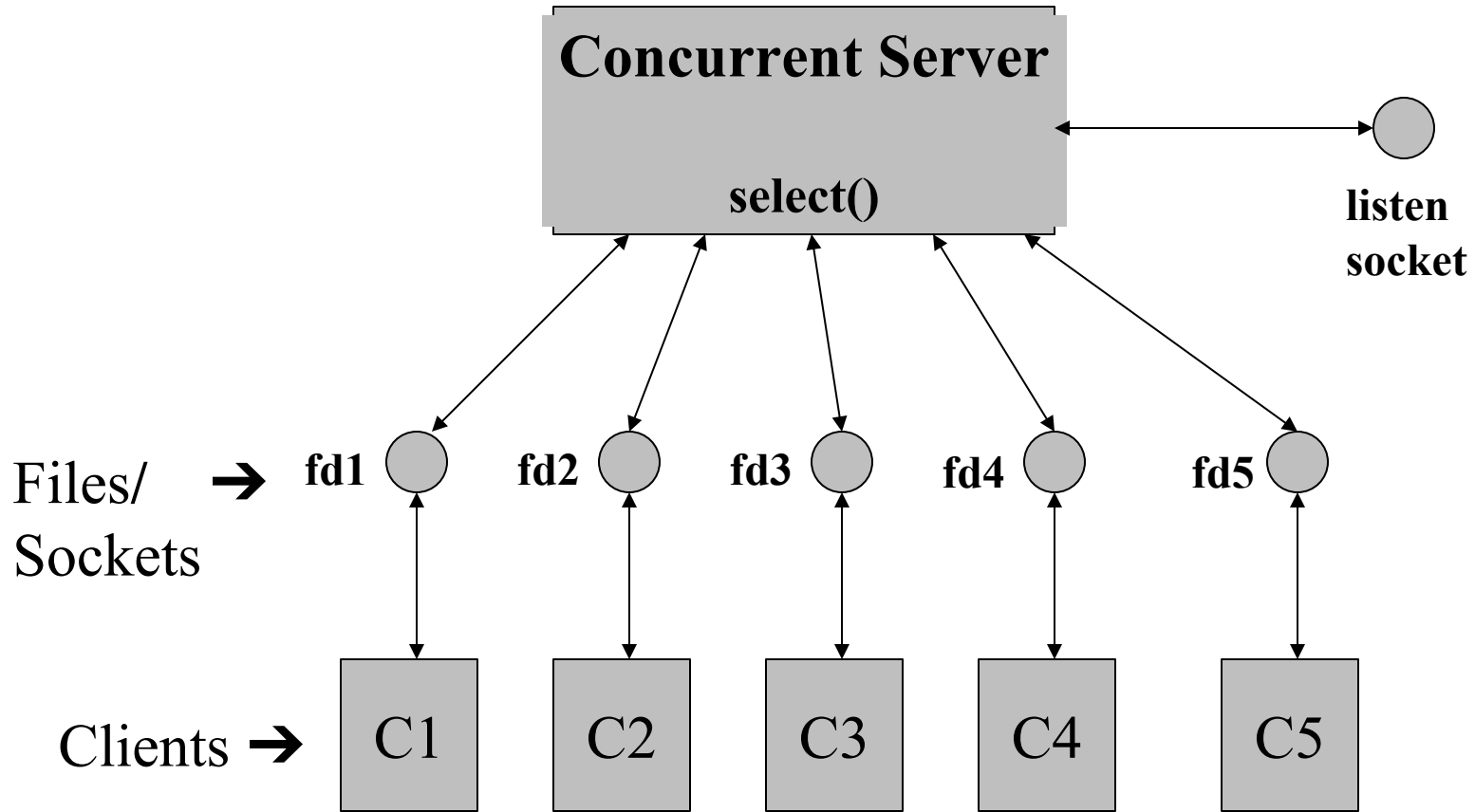

select() call

- Allows a process to wait for an event to occur on any one of its descriptors.
- Types of event
 - ready for read
 - ready for write
 - Exception condition

select() call

```
int  select(  
    int  maxfdp1,          /* max. fd + 1 */  
    fd_set  *readfds,     /* read ready? */  
    fd_set  *writefds,    /* write ready? */  
    fd_set  *exceptfds,   /* exceptions? */  
    struct timeval *timeout);  
  
struct  timeval {  
    long  tv_sec;  /* seconds */  
    long  tv_usec; /* microseconds */  
}
```

struct fd_set

- Set of descriptors that we want to wait on for events.
- Typically holds 256 descriptor states.
- Manipulation macros
 - void FD_ZERO(fd_set *fds)
 - void FD_SET (int fd, fd_set *fds)
 - void FD_CLR (int fd, fd_set *fds)
 - int FD_ISSET(int fd, fd_set *fds)

Non-forking Concurrent Server

```
fdset rdset, wrset;  
int listenfd, connfd1, connfd2;  
int maxfdp1;
```

.....

Connection establishment etc.

.....

```
/* initialize */  
FD_ZERO(&rdset);  
FD_ZERO(&wrset);
```

```

for( ;; ) {
    FD_SET(connfd1, &rdset);
    FD_SET(connfd2, &wrset);
    FD_SET(listenfd, &rdset);

    maxfdp1 = max(connfd1, connfd2, listenfd) + 1;

    /* wait for some event */
    Select(maxfdp1, &rdset, &wrset, NULL, NULL);

    if( FD_ISSET(connfd1, &rdset) ) {
        Read data from connfd1...
    }
    if( FD_ISSET(connfd2, &wrset) ) {
        Write data to connfd2...
    }
    if( FD_ISSET(listenfd, &rdset) ) {
        Process a new connection...
    }
}

```